

## CPS250-M Series

250 Watt AC-DC Power Supplies

### Data Sheet

**Total Power:** 250 Watts  
**Input Voltage:** 90 - 264 V  
**# of Outputs:** Single



### SPECIAL FEATURES

- Designed for forced air and natural convection cooling
- Medical and ITE safety approvals, 2x MOPP
- Dual fused
- Type BF ready
- Active Power Factor Correction, 61000-3-2 compliant
- Built-in Class B EMI filter
- Less than 1U high
- LPX100 enclosure kit available
- <500 mW no-load power consumption
- Compact size: 2" x 4" x 1.3"
- For use in Class I or Class II applications
- Three-year warranty (consult factory for extended terms)

### SAFETY

- EN 62368-1 / 60601-1
- UL/CSA 62368-1 / 60601-1
- CSA
- CE LVD Mark
- CCC

### Electrical Specifications

Input	
Input voltage range	90 - 264 Vrms
Frequency	47 - 63 Hz (360 - 440 Hz with higher leakage)
Inrush current	70 Apk, < 1 ms, cold start
Efficiency	93% typical
Leakage current	Specified for medical approvals
No load power	< 500 mW
Output	
Maximum power	250 W, forced-air cooling 155 W, free-air natural convection
Adjustment range	-0% / +10%
Holdup time	10 ms @ 225 W
Fan output	12 V @ 500 mA
Standby output	5 V @ 100 mA (For CPS253-M1 only)
Control and Protection	
Remote On/Off	For CPS253-M1 only
DC OK	For CPS253-M1 only
Overvoltage protection	Latching/AC Recycle required to restart PSU
Overcurrent protection	Auto-recovery
Short circuit protection	Auto-recovery (impedance <50 mOhm)
Overtemperature protection	Auto-recovery with hysteresis

\*\* CPS250-M tested according to the medical standard IEC 60601-1-2 4th Edition.

## Environmental Specifications

Operating temperature	-20 °C to +70 °C (derate at 50 °C), startup at -40 °C
Storage temperature	-40 °C to +85 °C
Operating humidity	5% to 90% (non-condensing)
Non-operating humidity	5% to 95% (non-condensing)
Maximum altitude	5000 m (3000 m for medical), derating may apply

## Other Specifications

Isolation	4000 Vac (input to output) 1500 Vac (input to PE; output to PE)
Line harmonics	61000-3-2, Class A
Conducted EMI*	Level B, CISPR 22 and FCC Part 15
Radiated EMI*	Level B, CISPR 22 and FCC Part 15
Surge immunity	Level 3, 61000-4-5, Criterion A
Medical EMC	60601-1-2, Edition 4 (cover may be required for some tests)
MTBF (Telcordia, Issue 3, Method 1 Case 3)	> 2.2 Mhrs, 25 °C, 155 W Natural Convection, 115 VAC > 5.1 Mhrs, 25 °C, 250 W Forced Air, 115 VAC

\*Applies to Class I input with ground tabs tied to a common ground plane and connected to system ground. Consult Technical Reference Notes for details.

## Pin Assignments

Connector	Pin Number	Designation	Mating Connectors
J5 (AC Input)	1 3 Mounting Holes	AC Input L1/Line AC Input L2/Neutral PE	Molex 09-50-8031 housing with 45570-3000 crimp or equivalent. Use AWG 20-18 wires.
J0 (DC Output)	1 2 3 4 5 6	Main Output Return Main Output Return Main Output Return Main Output Main Output Main Output	Molex 09-50-8061 housing with 45570-3000 crimp or equivalent. Use AWG 20-18 wires.
BusBar (DC Output) <i>Applies to 12 V variant only.</i>	1 2	Main Output Main Output Return	Ring terminal: Tyco 35148 or KST RV3-4 or equivalent.
J2 (Fan Supply)	1 2	Fan Return Fan Voltage	Cvilux: CI0102S0000 housing; CI01T01MPP0 crimp Landwin: 2001S0200 housing; 2005T011V crimp AWG # 30-24
J403 <i>Applies to CPS253-M1 only</i>	1 2 3 4 5	5 Vdc Standby Standby Return Remote Inhibit DC OK VFB (feedback loop pin)	Molex 504193-0500 with 504185-1000 crimp or equivalent. Use AWG 30-26 wires.

Mechanical Drawings - 12 V Variant

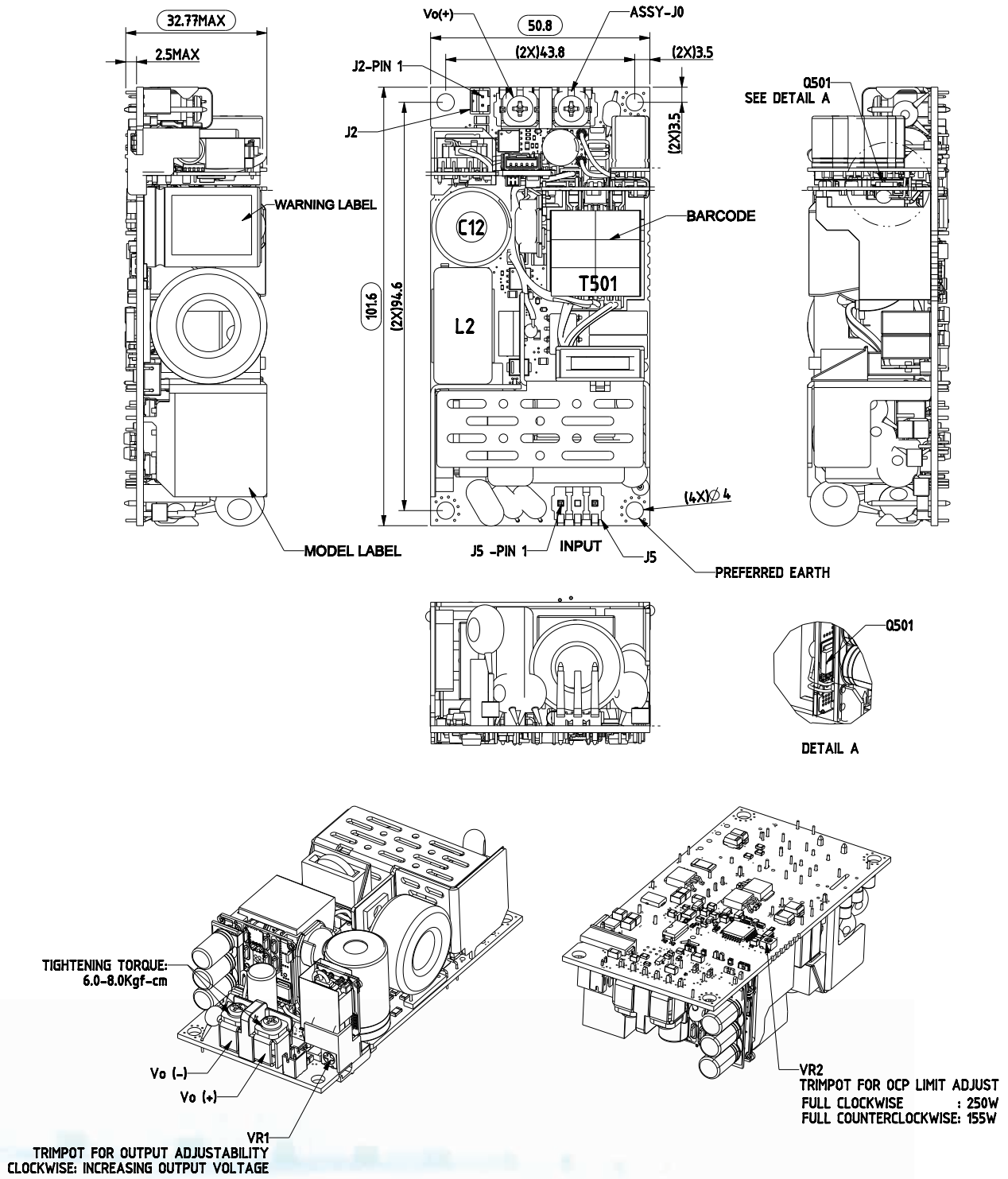



Mechanical Drawings - 24 V and 48 V Variants

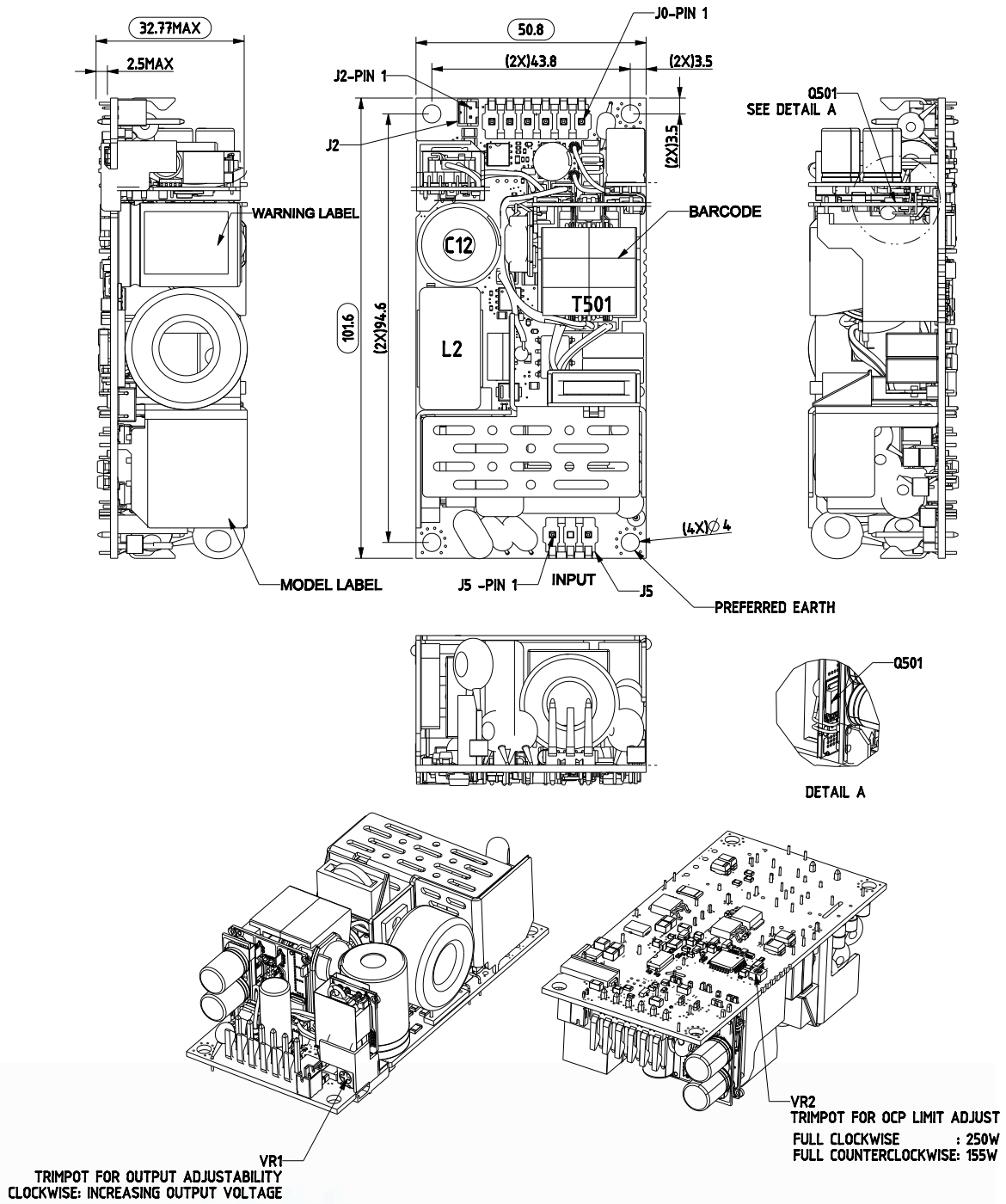

Mechanical Drawings - CPS253-M1

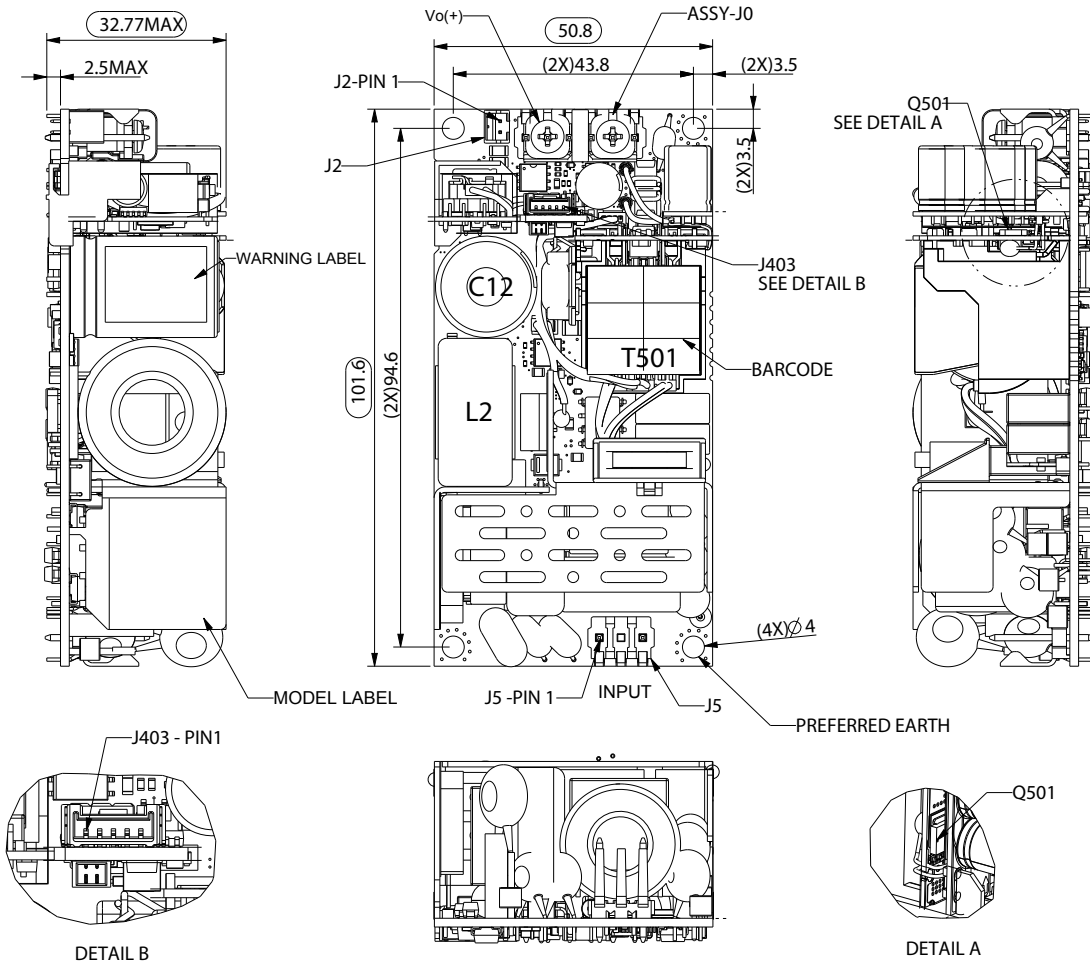

Notes:

1. OCP can not be adjusted on the fly. Default setting is for 250 W Forced Air.
2. Unit should be turned off before trimpot adjustment.
3. OCP does not vary linearly with the trimpot adjustment. It is either Full clockwise (250 W) or Full counter clockwise (155 W).
4. Thermal Hot Spot Reference - Do not exceed indicated temperature limits to ensure operation is within the component thermal derating limits. Measure the component temperatures using K type thermocouples.
5. Recommended Mounting Screw: M3.0 (4X) Pan head screw with teeth washer; 6 mm length; 6~8 Kgf-cm Torque.
6. Unit weight: 200 g max

Thermal Hot Spot Reference	
Component	Temperature Limit
L2	135 °C
T501	145 °C
Q501	120 °C
C12	95 °C

## Output Power Derating

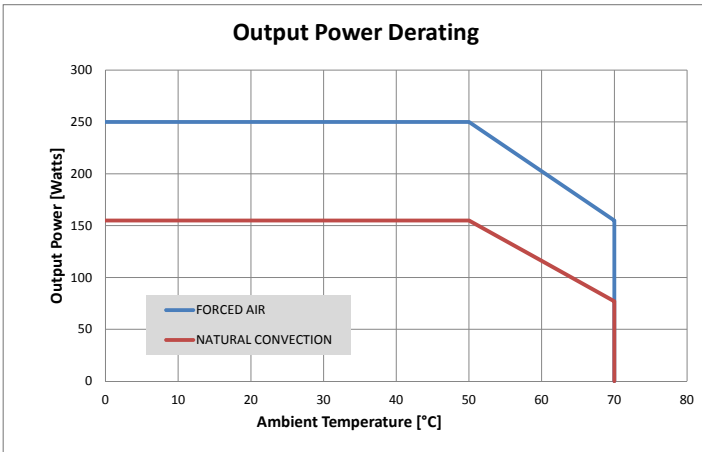

Figure 1. Output Power vs. Ambient Temperature at Natural Convection and Forced Air Cooling [300 LFM].

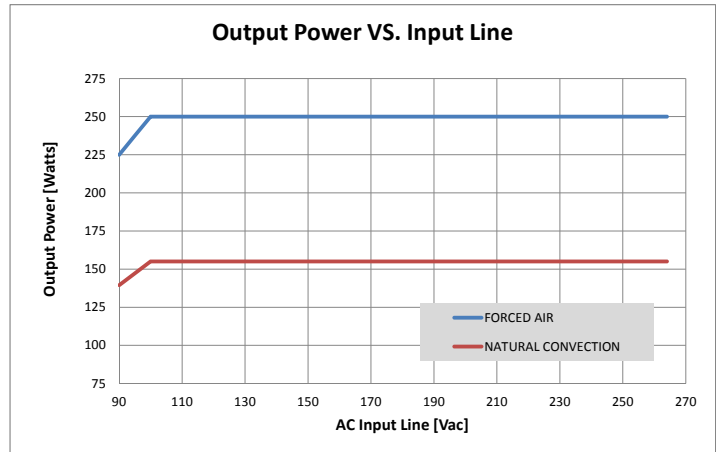

Figure 2. Output Power vs. Input Line at Natural Convection and Forced Air Cooling [300 LFM].

## Efficiency Curves

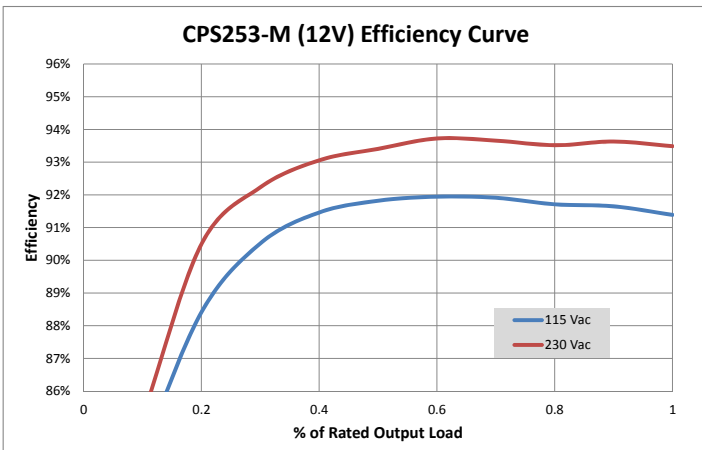

Figure 3. Typical Efficiency for 12 V Output

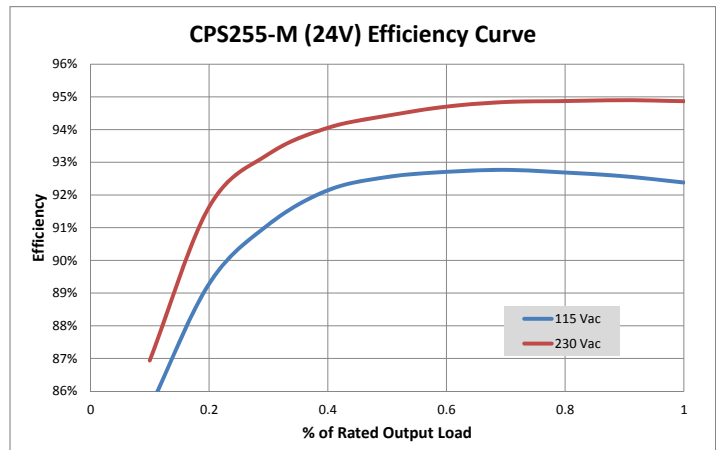

Figure 4. Typical Efficiency for 24 V Output

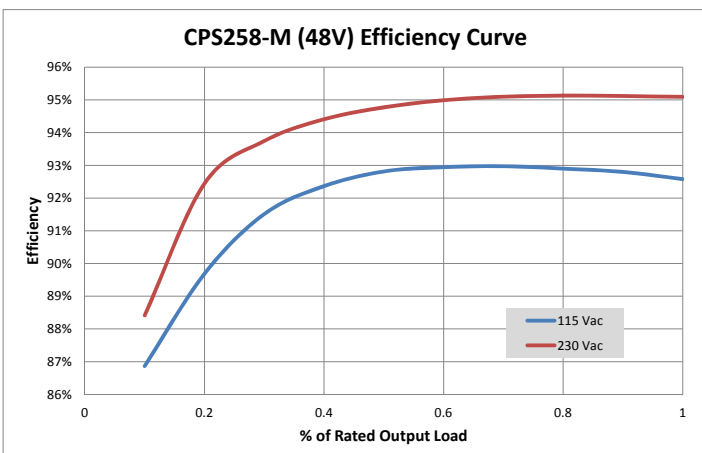

Figure 5. Typical Efficiency for 48 V Output

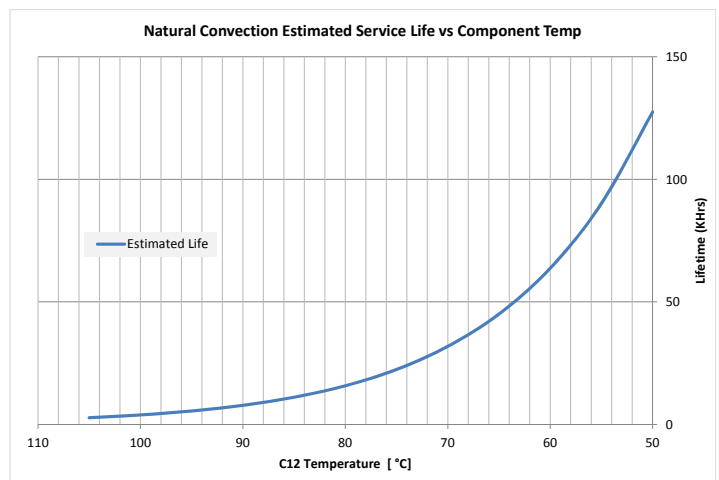

Figure 6. Estimated product useful life based on C12 (bulk capacitor) case temperature

## Ordering Information

Model number	Output voltage	Minimum load	Max. Continuous Load (Free Air)	Peak Load (Free Air) <sup>1</sup>	Max. Continuous Load (Forced Air) <sup>2</sup>	Regulation <sup>3</sup>	Ripple (p-p) <sup>4</sup>
CPS253-M	12 V	0 A	12.92 A	15.5 A	20.83 A	±2%	120 mV
CPS253-M1	12 V	0 A	12.92 A	15.5 A	20.83 A	± 2%	120 mV
CPS255-M	24 V	0 A	6.45 A	7.74 A	10.42 A	±2%	240 mV
CPS258-M	48 V	0 A	3.23 A	3.88 A	5.21 A	± 2%	480 mV

<sup>1</sup> Peak Load current not to exceed 30 seconds with maximum 10% duty cycle.

<sup>2</sup> Requires at least 300 LFM of airflow.

<sup>3</sup> At 25 °C including factory setpoint, Line voltage and Load current variations.

<sup>4</sup> Peak to peak ripple measured at the output terminals with 10µF tantalum capacitor in parallel with 0.1µF ceramic capacitor across the output & at 25 °C and output load ≥ 6W.

## Accessories and Connector Kits

Part Number	Description
70-841-032	CPS255-M (24 V) and CPS258-M (48 V): Complete mating connector kit for Input (J5); Output (J0) and 12 V fan supply (J2)
70-841-033	CPS253-M (12 V): Complete mating connector kit for Input (J5); DC busbar ring lugs and 12 V fan supply (J2)
70-841-034	CPS253-M1 (12 V + M1 option): Complete mating connector kit for Input (J5); DC busbar ring lugs; 12 V fan supply (J2) and “-M1” optional features (J403)

## WORLDWIDE OFFICES

### Americas

2900 South Diablo Way  
Suite B100  
Tempe, AZ 85282, USA  
+1 888 412 7832

### Europe (UK)

Ground Floor Offices, Barberrly House  
4 Harbour Buildings, Waterfront West  
Brierley Hill, West Midlands  
DY5 1LN, UK  
+44 (0) 1384 842 211

### Asia (HK)

14/F, Lu Plaza  
2 Wing Yip Street  
Kwun Tong, Kowloon  
Hong Kong  
+852 2176 3333

**ARTESYN**<sup>TM</sup>  
An Advanced Energy Company

[www.artesyn.com](http://www.artesyn.com)

Artesyn Embedded Technologies, Artesyn Embedded Power, Artesyn, and all Artesyn related logos are trademarks and service marks of Artesyn Embedded Technologies, Inc. All other names and logos referred to are trade names, trademarks, or registered trademarks of their respective owners. Specifications are subject to change without notice. © 2020 Artesyn Embedded Technologies, Inc. All rights reserved. For full legal terms and conditions, please visit [www.artesyn.com/legal](http://www.artesyn.com/legal).

For more information: [www.artesyn.com](http://www.artesyn.com)  
For support: [productsupport.ep@artesyn.com](mailto:productsupport.ep@artesyn.com)