

Datasheet

µMP Series GEN II

Artesyn

Our company network supports you worldwide with offices in Germany, Austria, Switzerland, Great Britain and the USA. For more information please contact:

FORTEC Elektronik AG

Hauptniederlassung
Lechwiesenstr. 9
86899 Landsberg am Lech

Telefon: +49 (0) 8191 91172-0
Telefax: +49 (0) 8191 21770
E-Mail: sales@fortecag.de
Internet: www.fortecag.de

FORTEC Elektronik AG

Büro Nord
Am Hasenkamp 36
22457 Hamburg

Telefon: +49 (0) 40 54 80 56 11
Telefax: +49 (0) 40 54 80 56 13
E-Mail: nord@fortecag.de
Internet: www.fortecag.de

FORTEC Elektronik AG

Büro West
Hohenstaufenring 55
50674 Köln

Telefon: +49 (0) 221 272 273-0
Telefax: +49 (0) 221 272 273-10
E-Mail: west@fortecag.de
Internet: www.fortecag.de

FORTEC Elektronik AG

Büro Wien
Nuschinggasse 12
A-1230 Wien

Telefon: +43 1 8673492-0
Telefax: +43 1 8673492-26
E-Mail: office@fortec.at
Internet: www.fortec.at

ALTRAC AG

(Tochter der FORTEC):
Bahnhofstraße 3
CH-5436 Würenlos

Telefon: +41 (0) 44 7446111
Telefax: +41 (0) 44 7446161
E-Mail: info@altrac.ch
Internet: www.altrac.ch

The information contained in this document has been carefully researched and is, to the best of our knowledge, accurate. However, we assume no liability for any product failures or damages, immediate or consequential, resulting from the use of the information provided herein. Our products are not intended for use in systems in which failures of product could result in personal injury. All trademarks mentioned herein are property of their respective owners. All specifications are subject to change without notice.

POWER

µMP Series GEN II

Up to 1800 Watts with New Product Enhancements

Data Sheet

Total Power: Up to 1800 Watts Peak*
Input Voltage: 85 - 264 Vac
 120 - 300 Vdc
of Outputs: Up to 12



SPECIAL FEATURES

- Full Medical EN60601 approval
- PMBus monitor/control of input functions
- High efficiency
- Constant current limit protection
- High power density.
 - µMP04: 10.8 W/cu-in
 - µMP10: 15.1 W/cu-in
 - µMP16: 22.9 W/cu-in
- Low noise intelligent fan (speed control/fault status), 36% reduction from GEN I
- Downloadable GUI from website
- Optional conformal coating
- Industrial temp range (-40 °C to 70 °C)
- No preload required
- Military STD shock/vibration (40G's)
- Low cost
- IEC, terminal block or barrier strip input connection options
- Low profile 1U size
- Superior aesthetics over GEN I

CERTIFICATIONS

- UL UL60950-1 / CSA 22.2 No.60950-1/ ES60601-1 / CSA 22.2 No.60601-1
- TUV EN60950-1 / EN60601-1
- CB Certificate and Report
- CE Compliance to LVD and RoHS Directives
- CQC Approved
- Medical 2x MOPP

Electrical Specifications

Input	
Input range	85 - 264 Vac, 120 - 350 Vdc (limited to 300 Vdc in medical applications)
Frequency	47 - 440 Hz
Inrush current	40 A peak max. (soft start)
Efficiency	Up to 91.5% @ full case load
Power factor	0.99 typ. meets EN61000-3-2 (n/a @ 440 Hz)
Standby power	µMP10/16 < 13 W µMP04 < 6 W
Turn-on time	AC on 2 sec for µMP16/10 and 1.5 sec for µMP04, inhibit/enable 250 ms typical
EMI:	CISPR 22/EN55022 Level "B" (Both Conducted and Radiated)
Leakage current	<200 uA using center-tapped xfmr measurement method. (<400 uA @ 264 VAC input)
Holdover storage	16.7 ms minimum (independent of input Vac, 0 °C to 50 °C) At 1200 W for µMP16
AC OK	Signal goes low indicating loss of AC input. Hold up = Full cycle ride thru (50 Hz); Open collector
Harmonic current emission	Meets EN61000-3-2
Isolation	Meets EN60950 and EN60601
Global inhibit/enable	TTL, Logic "1" and Logic "0"; fan off when unit is inhibited
Input fuse (internal)	µMP16/10: 16 A, 500 Vac, 400 Vdc, µMP04: 10 A / 250 V. (both lines fused)
Warranty	2 years
Output	
Factory set point accuracy	± 1%
Margining / V-Program	± 3 - 7% nominal analog (single output module only). Contact factory for simple V-program modification (i.e. 0-5 V input = 0-100% output voltage).
Overall regulation	0.4% or 30 mV which ever is greater
Ripple	RMS: 0.1% or 10 mV, whichever is greater Pk-Pk: 1.0% or 50 mV, whichever is greater. Bandwidth limited to 20 MHz
Dynamic response	< ± 5% or 250 mV, with 50% step load
Recovery time	To within 1% in < 300 µsec
Reverse voltage protection	100% of rated output current

* Max output power for µMP16: 1000 W 90 - 100 VAC; 1200 W 100 - 180 VAC; 1600 W 180 - 200 W; 1800 W 200 - 264 VAC. Operational specs for EMI and Hold-up are valid to 1600 W max.

Electrical Specifications

Output	
Thermal protection (OTP)	All outputs disabled when internal temp exceeds safe operating range
Remote sense	Up to 0.5 V total drop (not available on triple output module)
Single wire parallel	Current share to within 5% of total rated current from 20% to 100% rated load
DC OK	± 5% of nominal Open collector
Minimum load	Not required
Housekeeping standby	5 Vdc @ 2.0 A max whenever AC input is applied. 1.0 A (2.0 A for µMP04) max convection cooled (when output is inhibited off)
Module inhibit	Logic - output on with low or open. Different logic options available
Output/Output isolation	> 1 Megohm, 500 V

Environmental Specifications

Operating temperature	-40 °C to 70 °C ambient. Derate each output 2.5% per degree from 50 °C to 70 °C. Cold start soak -20 °C, allow 10 min warm-up before all outputs are within specification. Reverse air to 40 °C Max due to fan derating.
Storage temperature	-40 °C to +85 °C
Electromagnetic susceptibility	Designed to meet EN61000-4:-3,-5,-6,-11 Class 3 Performance Criteria A
Humidity	Operating; non-condensing 10% to 95% RH
Vibration	MIL-STD-810E
MTBF demonstrated	> 350,000 hours at full load, one µMP04 case + two modules, Telcordia SR-332 calculated MTBF
Altitude	Up to 10 K feet; derate linear to 50% from 10 K - 30 K feet

Vout	Full load (A)	OVP trip max (V)	OCP trip typ (Iout%)	SCP trip max (Iout%)	Overshoot (max mV)	Peak Deviation (max mV)
3 V 3 Module						
0.9	40	2.00 V	130%	160%	150	± 250
3.3	40	5.96 V	130%	160%	250	± 250
3.6	40	6.31 V	130%	160%	250	± 250
5 V Module						
3.2	36	5.76 V	130%	160%	250	± 250
5	36	9.0 V	130%	160%	250	± 250
6	30	10.80 V	130%	160%	300	± 300
12 V Module						
6	25	10.80 V	130%	160%	300	± 300
12	20	15.60 V	130%	160%	600	± 600
15	16	19.50 V	130%	160%	750	± 750
24 V Module						
12	13	15.60 V	130%	160%	600	± 600
24	10	31.20 V	130%	160%	120	± 1200
30	8	39.00 V	130%	160%	1500	± 1500
48 V Module						
28	7	36.40 V	130%	200%	1400	± 1400
48	5	62.40 V	130%	160%	2400	± 2400
60	4	78.00 V	130%	200%	3000	± 3000

Case Line-Up

Case	Max Output		Dimensions	Connections	Max Continuous Current
	85-180 VAC	180-263 VAC			
μMP04 - 4 Slot	400 W	600 W	256.9 x 88.9 x 40.0 (10.11" x 3.5" x 1.57")	IEC Terminal-Block Barrier-Strip	9.91
μMP10 - 6 Slot	1000 W	1200 W	256.9 x 127 x 40.0 (10.11" x 5.0" x 1.57")	IEC Terminal-Block Barrier-Strip	13.87
μMP16 - 6 Slot	1000 W	1800 W	256.9 x 127 x 40.0 (10.11" x 5.0" x 1.57")	IEC Terminal-Block Barrier-Strip	13.87

Output Module Line-Up S2*

Output Range (Vdc)	Max Current (Amps)	Max Power (Watts)	Module Codes Standard Outputs
0.9 - 3.6	40	144	A, B, C, D - 2, 2.2, 3, 3.3
3.2 - 6.0	36	180	E, F, G, H - 5, 5, 2, 5.5, 6.0
6.0 - 15.0	25	240	I, J, K, L, M, N - 8, 10, 11, 12, 14, 15
12.0 - 30.0	13	240	O, P, Q, R, S - 18, 20, 24, 28, 30
33.0 - 60.0	7	240	T, U, V, W, X, Y - 33, 36, 42, 48, 54, 60
3.3 - 30.0	4/4	96/96	Dual Output Module. Each output is rated to 96 W (192 Watts total). Wide range is adjustable.

Output Module Line-Up SK*

Output Range (Vdc)	Max Current (Amps)	Max Power (Watts)	Module Codes Standard Outputs
18.0 - 30.0	42	1000	O, P, Q, R, S (18, 20, 24, 28, 30 Volts)
33.0 - 60.0	21	1000	T, U, V, W, X, Y (33, 36, 42, 48, 54, 60 Volts)

Ordering Information

μMPXY	- SKW - S2E - S2Q - ILL -	00	- A	- ###
Case Size	Module/Voltage	Case Option Codes	Software Code	Hardware Code
1-Phase Input where X = 4 = 1.57" x 3.5" x 10.0"; 400W - 600W 4 Slots* 04 = 1.57" x 3.5" x 10.0"; 400W - 600W 4 Slots 1 = 1.57 x 5.0" x 10.0", 1000W-1200W, 6 Slots* 10 = 1.57 x 5.0" x 10.0", 1000W-1200W, 6 Slots 16 = 1.57" x 5.0" x 10.0", 1200W-1800W**, 6 Slots * Not Recommended for new designs ** See Input Derating table below for uMP16 Input Type where Y = T = Terminal Block C = IEC Connector C14 S = Barrier Strip	Module Codes: S2 = 200 W Single O/P (1 Slot) SK = 1000 W Single O/P (3 Slot) I = 96 W Dual O/P ISO GND (1 Slot) Voltage Codes: See voltage code table	First digit 0-9 = Parallel Code Second Digit 0 = No Options 1 = Reverse Air 2 = Not Used 3 = Global Enable 5 = Opt 1 + Opt 3	Factory assigned for modified standards	

μMP16 INPUT POWER DERATING

Parameter	85 - 99 Vac	100 - 140 Vac	180 - 199 Vac	200 - 264 Vac
Designed For	1000 W	1200 W	1600 W	1800 W
QAV Evaluation	1000 W	1200 W	1600 W	1800 W
Safety Label and Evaluation	1000 W	1000 W	1600 W	1600 W

Parallel Codes

Code	Slots in Parallel	Code	Slots in Parallel	Code	Slots in Parallel	Code	Slots in Parallel
1	1&2	6	1&2&3	A	1&2; 3&4	0	no module in parallel
2	2&3	7	1,2,3&4	B	1,2&3; 4&5	H	3,4&5
3	3&4	8	1,2,3,4&5	C	1,2,3&4; 5&6	J	3,4,5&6
4	4&5	9	1,2,3,4,5&6	D	1&2; 3&4; 5&6	K	4,5&6
5	5&6			E	1,2&3; 4,5&6		

Notes:

Parallel between SK* (1000 W Modules) and S2* (240 W Modules) will use the codes as follows

Code 3 to parallel 2 SK* modules

Code 3 to parallel 1 SK* module and 1 S2* module

Code H to parallel 1 SK* module and 2 S2* modules

Voltage Codes

Standard Output Ratings

Module Output Voltage Code		Single Output One Slot 240 Watts Max	Single Output Three Slots 1000 Watts Max	Dual Output One Slot 96 Watts	
Module Identification		S2	SK*	I	
Code	Volts	Output Current V1	Output Current V1	Output Current	
				V1	V2
A	2.0	40.0	-	NA	
B	2.2	40.0	-	NA	
C	3.0	40.0	-	NA	
D	3.3	40.0	-	4.0	4.0
E	5.0	36.0	-	4.0	4.0
F	5.2	34.0	-	4.0	4.0
G	5.5	32.0	-	4.0	4.0
H	6.0	30.0	84.0	4.0	4.0
I	8.0	25.0	84.0	4.0	4.0
J	10.0	24.0	84.0	4.0	4.0
K	11.0	22.0	84.0	4.0	4.0
L	12.0	20.0	84.0	4.0	4.0
M	14.0	17.0	71.4	4.0	4.0
N	15.0	16.0	66.7	4.0	4.0
O	18.0	13.0	42.0	4.0	4.0
P	20.0	12.0	42.0	4.0	4.0
Q	24.0	10.0	42.0	4.0	4.0
R	28.0	8.6	35.7	3.4	3.4
S	30.0	8.0	33.3	3.2	3.2
T	33.0	7	21.0	NA	
U	36.0	6.7	21.0	NA	
V	42.0	5.7	21.0	NA	
W	48.0	5.0	21.0	NA	
X	54.0	4.4	18.5	NA	
Y	60.0	4.0	16.7	NA	

* Note: For 1000 W module, Output Voltage from 33.0-60.0 V are available. Contact factory for availability of other output ranges

Derating Curves - µMP10

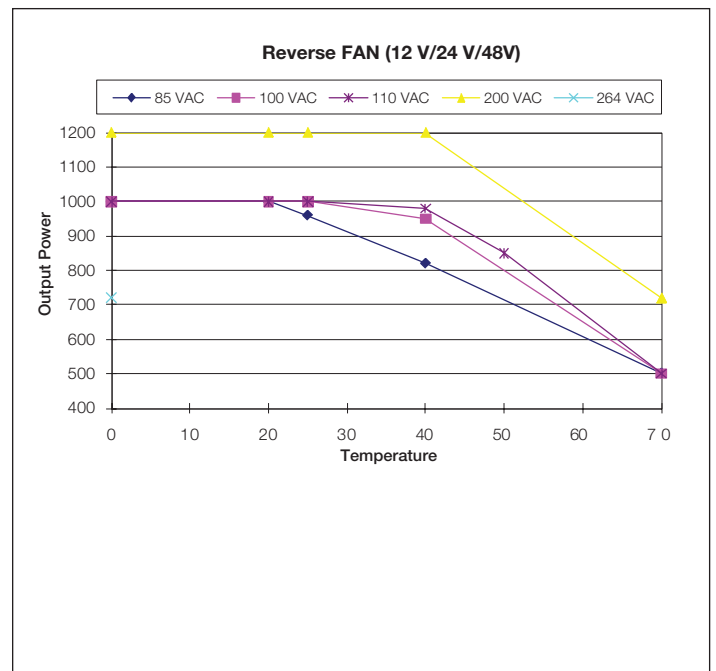
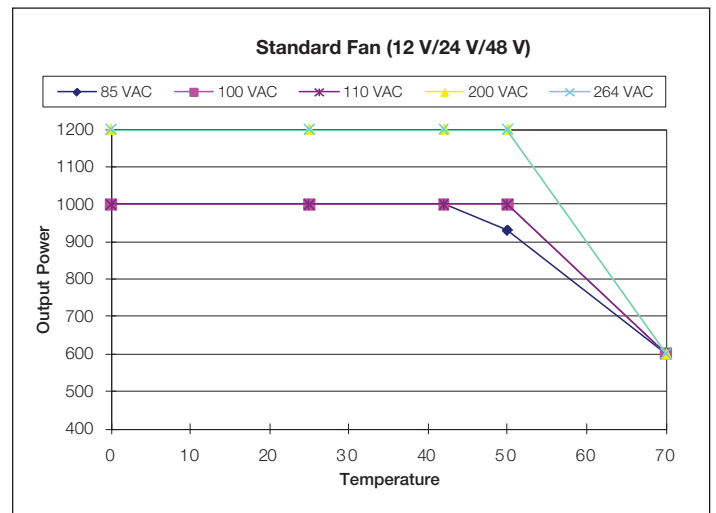

μMP04 (AC input on opposite side)

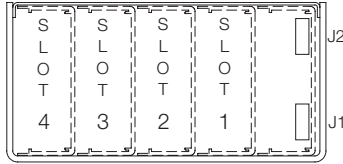

μMP04 = 4 available slots
 85 - 264 Vac 200 - 264 Vac
 400 W max. 600 W max.

μMP10/16 (AC input on opposite side)

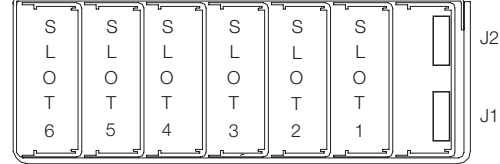

μMP10 = 6 available slots
 μMP16 = 6 available slots
 85 - 264 Vac 200 - 264 Vac
 1000 W max. 1200 W max.
 1200 W max. 1800 W max.

Pin Connectors

Figure 1. AC Input



IEC Connector



Terminal Block

AC Input	
Pin	Function
1	AC neutral
2	AC line (hot)
3	Chassis (earth) ground

Mates with
 Landwin 2050S1000 Housing
 2053T011V Pin
 or

JST PHDR-10VS Housing
 JST SPHD-002T-P0.5 (28-24)
 JST SPHD-001T-P0.5 (26-22)

Connector Kit Part No.:
 70-841-023

J2 I²C Bus Output Connector

Pin	Function
1	5 Vcc bus
2	Serial data signal (SDA)
3	Secondary return (COM)
4	Serial clock signal (SCL)
5	Address bit 2 (A2)
6	No connection
7	Address bit 1 (A1)
8	No connection
9	Address bit 0 (A0)
10	No connection

J1 PFC Input Connector (control & signals)

Pin	Function
1	Input AC OK - "emitter"
2	Input AC OK - "collector"
3	Global DC OK - "emitter"
4	Global DC OK - "collector"
5	Spare
6	Global inhibit/optional enable logic "1"
7	Global inhibit/optional enable logic "0"
8	Global inhibit/optional enable return
9	+5 VSB housekeeping
10	+5 VSB housekeeping return

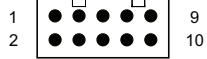
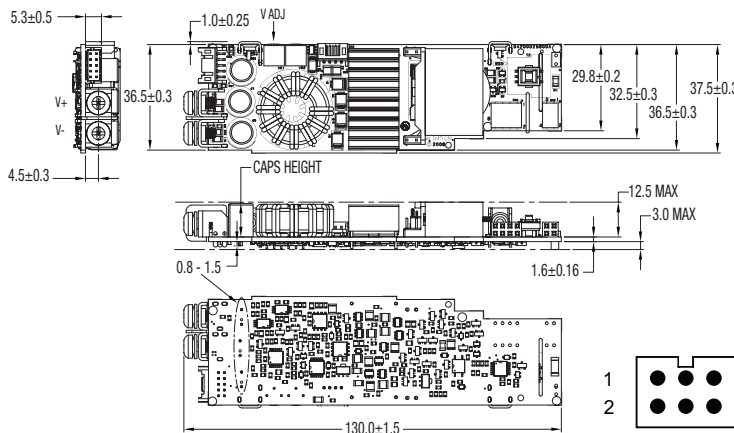
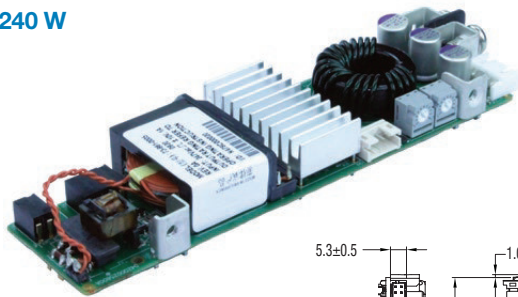

Figure 2. Connector J1 & J2

S2 Module

240 W



DC Output Control & Signals (Single output)

Pin	Function
1	No connection
2	No connection
3	Current share
4	Module inhibit return
5	Module ISO inhibit
6	SCOM
7	-RMT sense
8	Margin
9	Remote margin / V prog.
10	+RMT sense

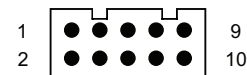

SK Module

1000 W



12/24 Volt Output:

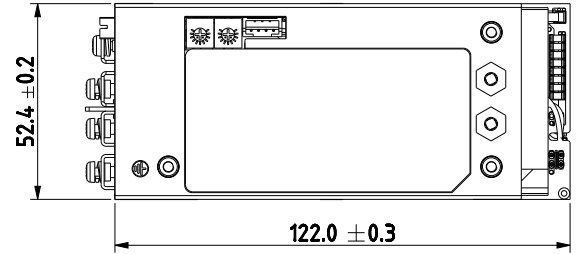
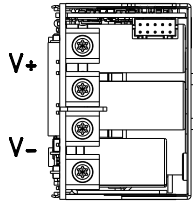

48 V Output:

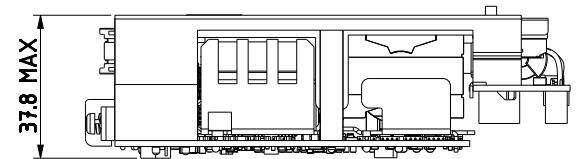
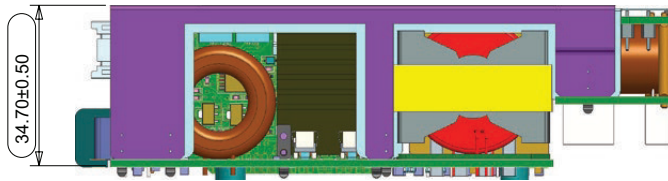
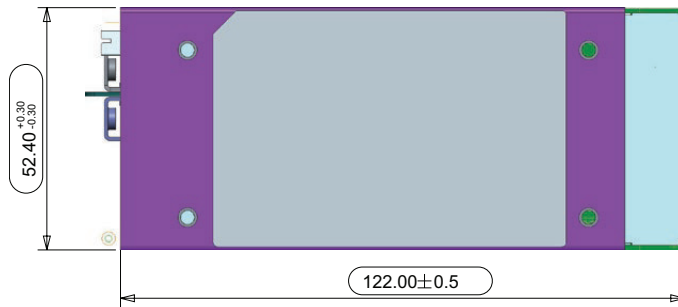

DC Output Control & Signals (Single output)

Pin	Function
1	No connection
2	No connection
3	Current share
4	Module inhibit return
5	Module ISO inhibit
6	SCOM
7	-RMT sense
8	Margin
9	Remote margin / V prog.
10	+RMT sense

Dual Module

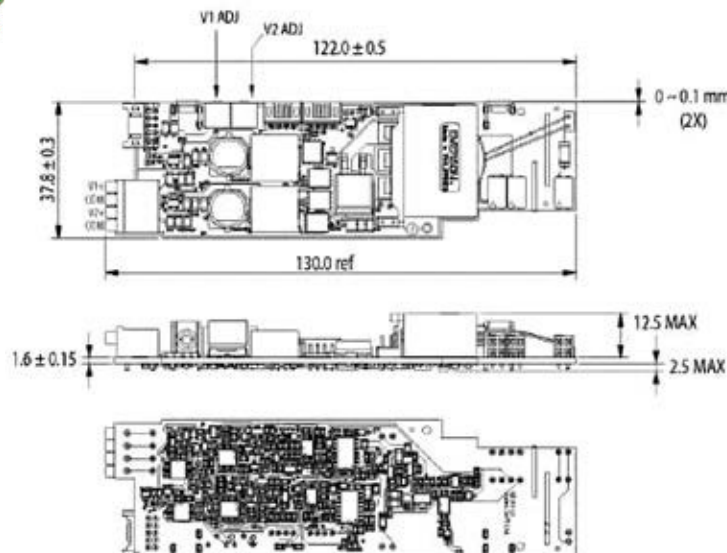

DC Output Control & Signals (Dual output)

Pin	Function
1	-RMT sense V2
2	+RMT sense V2
3	No connection
4	Module inhibit rtn
5	Module ISO inhibit
6	SCOM
7	-RMT sense V1
8	No connection
9	No connection
10	+RMT sense V1

µMP Series

µMP04 (400/600 Watts Max)

Case Size: µMP04: 10.11" x 3.5" x 1.57" (256.9 mm x 88.9 mm x 40.0 mm)

Weight: µMP04 Case: 1.96 lbs • Single O/P: 0.22 lb.
 • Dual O/P: 0.16 lb. • Blank: 0.06 lb.

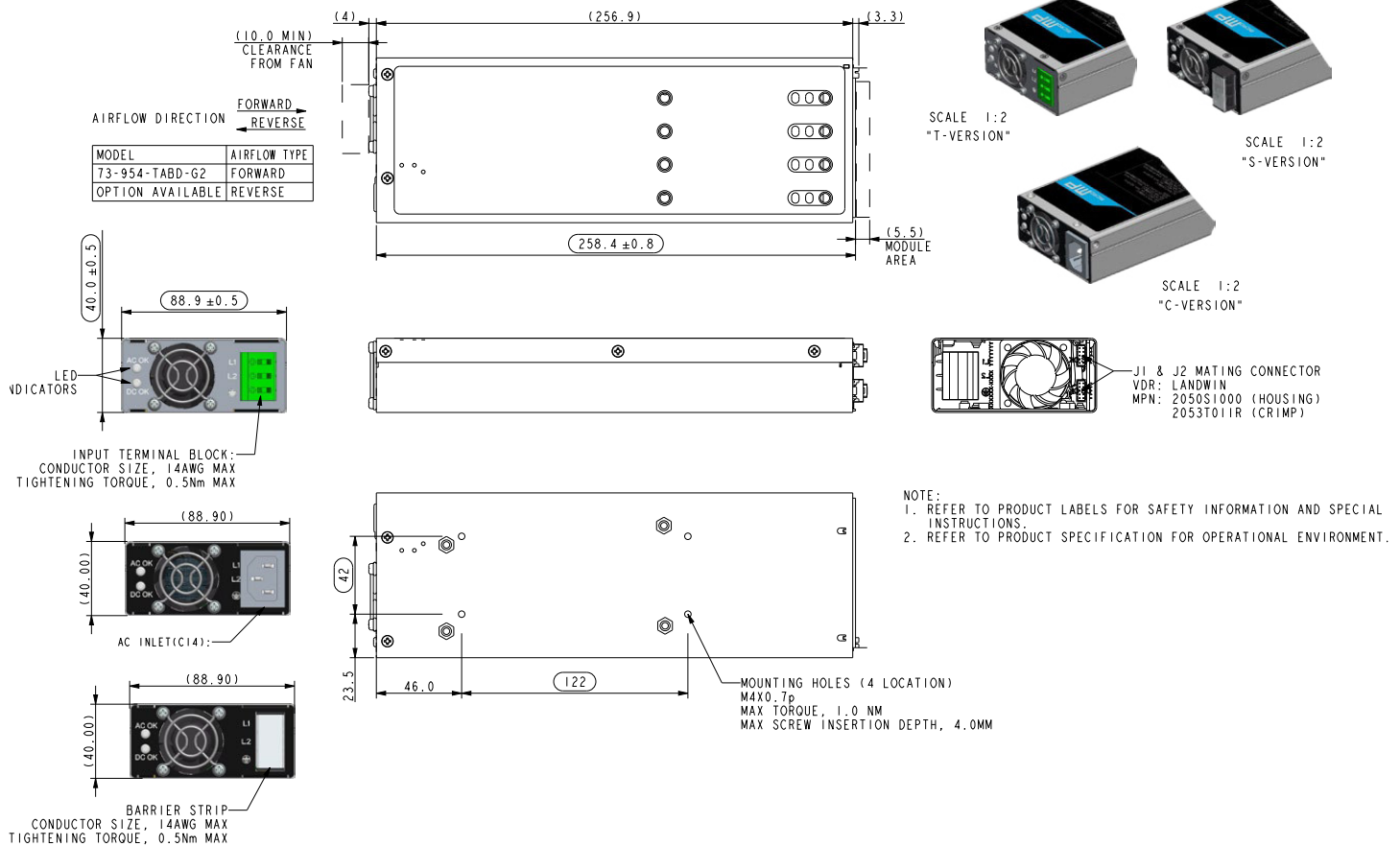

- Notes:**
- Input: IEC 60320 C13 (for IEC connector)
 Barrier Type DECA Switchlab MT300-50003 (for terminal block connector); Max Torque: 4.0 lb-in (0.4 - 0.5 Nm); Wire: 12 - 16 AWG; Wire Strip Length: 0.354" (9.0 mm)
 - Control Connectors (J1 and J2): 10-position housing, brass, matte tin-plated contacts. Mates with housing 2050S1000 (Landwin) with 2053T011P (Landwin) pins or housing PHDR-IOVS (JST) and SPHD-002T-PO.5 (JST) pins.
 - Output Module Connectors: All single O/P modules are M4 x 10 mm screws; tighten between 6.94 to 8.68 lb-in (8.0 to 10.0 kg-cm). Dual O/P module is PUSH IN conductor connector; Wire Strip Length: 0.315" (8.0 mm); Control signal connector: Refer to Item 2.
 - Chassis Material: Steel with chemical film coating (conductive).
 - Customer Mounting: Screw M4-type mounting holes; Max. Penetration is 0.138" (3.5 mm); Max. Torque: 8.85 lb-in (1.0 N-m)
 - All dimensions are in millimeters and inches, and are typical.

µMP10 (1000/1200 Watts Max)
µMP16 (1200/1800 Watts Max)

Case Size: µMP10/16: 10.11" x 5" x 1.57" (256.9 mm x 127 mm x 40.0 mm)

Weight: µMP10/16 Case: 2.78 lbs • Single O/P: 0.22 lb.
 • Dual O/P: 0.16 lb. • Blank: 0.06 lb.

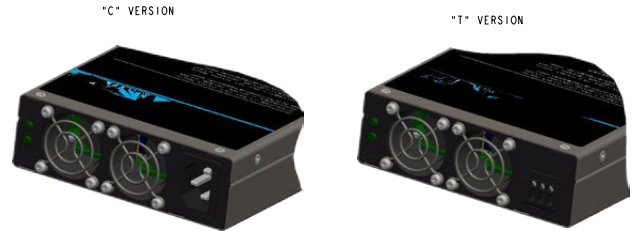
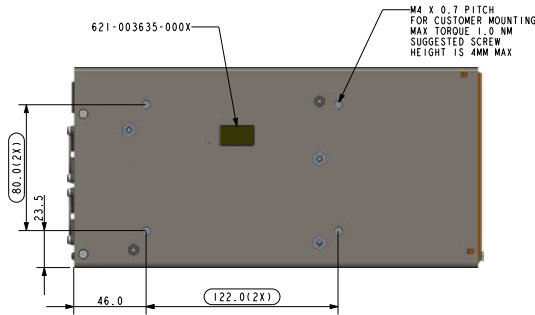
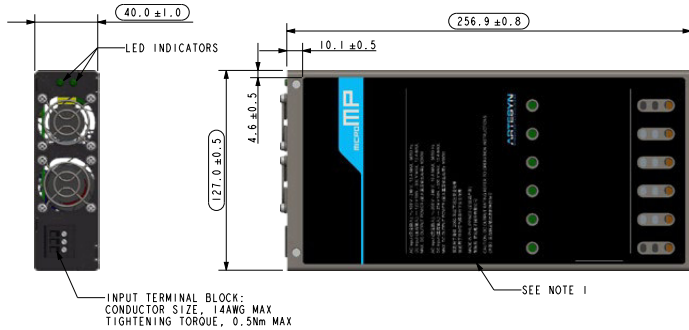

SCALE 1:2

SCALE 1:2



SCALE (1:2)

NOTES
 1. BLACK TOP COVER LABEL, REFER TO IPN 534-000824-000X FOR DETAILS
 2. DIMENSIONS ARE IDENTIFIED FOR INSPECTION BY BEING ENCLOSED IN AN OBOUND.

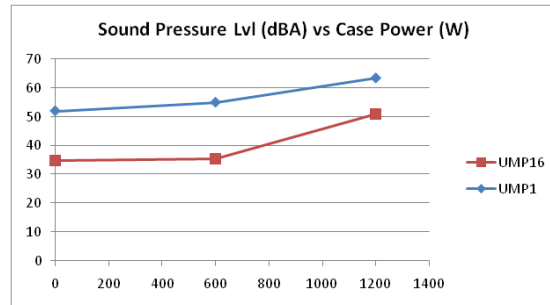

- Notes:**
- Input: IEC 60320 C13 (for IEC connector)
 Barrier Type DECA Switchlab MT300-50003 (for terminal block connector); Max Torque: 4.0 lb-in (0.4 - 0.5 Nm); Wire: 12 - 16 AWG; Wire Strip Length: 0.354" (9.0 mm)
 - Control Connectors (J1 and J2): 10-position housing, brass, matte tin-plated contacts. Mates with housing 2050S1000 (Landwin) with 2053T011P (Landwin) pins or housing PHDR-IOVS (JST) and SPHD-002T-PO.5 (JST) pins.
 - Output Module Connectors: All single O/P modules are M4 x 10 mm screws; tighten between 6.94 to 8.68 lb-in (8.0 to 10.0 kg-cm). Dual O/P module is PUSH IN conductor connector; Wire Strip Length: 0.315" (8.0 mm); Control signal connector: Refer to Item 2.
 - Chassis Material: Steel with chemical film coating (conductive).
 - Customer Mounting: Screw M4-type mounting holes; Max. Penetration is 0.138" (3.5 mm); Max. Torque: 8.85 lb-in (1.0 N-m)
 - All dimensions are in millimeters and inches, and are typical.

WORLDWIDE OFFICES

Americas

2900 S.Diablo Way
 Tempe, AZ 85282
 USA
 +1 888 412 7832

Europe (UK)

Waterfront Business Park
 Merry Hill, Dudley
 West Midlands, DY5 1LX
 United Kingdom
 +44 (0) 1384 842 211

Asia (HK)

14/F, Lu Plaza
 2 Wing Yip Street
 Kwun Tong, Kowloon
 Hong Kong
 +852 2176 3333



www.artesyn.com

Artesyn Embedded Technologies, Artesyn and the Artesyn Embedded Technologies logo are trademarks and service marks of Artesyn Embedded Technologies, Inc. All other names and logos referred to are trade names, trademarks, or registered trademarks of their respective owners. © 2016 Artesyn Embedded Technologies, Inc. All rights reserved. For full legal terms and conditions, please visit www.artesyn.com/legal.

For more information: www.artesyn.com/power
 For support: productsupport.ep@artesyn.com

FORTEC

ELEKTRONIK AG

Our company network supports you worldwide with offices in Germany, Austria, Switzerland, Great Britain and the USA. For more information please contact:

FORTEC Elektronik AG

Hauptniederlassung
Lechwiesenstr. 9
86899 Landsberg am Lech

Telefon: +49 (0) 8191 91172-0
Telefax: +49 (0) 8191 21770
E-Mail: sales@fortecag.de
Internet: www.fortecag.de

FORTEC Elektronik AG

Büro Nord
Am Hasenkamp 36
22457 Hamburg

Telefon: +49 (0) 40 54 80 56 11
Telefax: +49 (0) 40 54 80 56 13
E-Mail: nord@fortecag.de
Internet: www.fortecag.de

FORTEC Elektronik AG

Büro West
Hohenstaufenring 55
50674 Köln

Telefon: +49 (0) 221 272 273-0
Telefax: +49 (0) 221 272 273-10
E-Mail: west@fortecag.de
Internet: www.fortecag.de

FORTEC Elektronik AG

Büro Wien
Nuschinggasse 12
A-1230 Wien

Telefon: +43 1 8673492-0
Telefax: +43 1 8673492-26
E-Mail: office@fortec.at
Internet: www.fortec.at

ALTRAC AG

(Tochter der Fortec AG):
Bahnhofstraße 3
CH-5436 Würenlos

Telefon: +41 (0) 44 7446111
Telefax: +41 (0) 44 7446161
E-Mail: info@altrac.ch
Internet: www.altrac.ch

Members of the FORTEC Group:

