

Datasheet

RCB 600

ROAL

Our company network supports you worldwide with offices in Germany, Austria, Switzerland, Great Britain and the USA. For more information please contact:

FORTEC Elektronik AG

Hauptniederlassung
Lechwiesenstr. 9
86899 Landsberg am Lech

Telefon: +49 (0) 8191 91172-0

Telefax: +49 (0) 8191 21770

E-Mail: sales@fortecag.de

Internet: www.fortecag.de

FORTEC Elektronik AG

Büro Nord
Am Hasenkamp 36
22457 Hamburg

Telefon: +49 (0) 40 54 80 56 11

Telefax: +49 (0) 40 54 80 56 13

E-Mail: nord@fortecag.de

Internet: www.fortecag.de

FORTEC Elektronik AG

Büro West
Hohenstaufenring 55
50674 Köln

Telefon: +49 (0) 221 272 273-0

Telefax: +49 (0) 221 272 273-10

E-Mail: west@fortecag.de

Internet: www.fortecag.de

FORTEC Elektronik AG

Büro Wien
Nuschinggasse 12
A-1230 Wien

Telefon: +43 1 8673492-0

Telefax: +43 1 8673492-26

E-Mail: office@fortec.at

Internet: www.fortec.at

ALTRAC AG

(Tochter der FORTEC):
Bahnhofstraße 3
CH-5436 Würenlos

Telefon: +41 (0) 44 7446111

Telefax: +41 (0) 44 7446161

E-Mail: info@altrac.ch

Internet: www.altrac.ch

The information contained in this document has been carefully researched and is, to the best of our knowledge, accurate. However, we assume no liability for any product failures or damages, immediate or consequential, resulting from the use of the information provided herein. Our products are not intended for use in systems in which failures of product could result in personal injury. All trademarks mentioned herein are property of their respective owners. All specifications are subject to change without notice.

DESCRIPTION

The RCB600 is a series of modular, configurable power supplies that provide high performance and outstanding flexibility.

Delivering 600 W from a 600 g, 5" x 3" x 1U package, the RCB600 is the smallest commercially available configurable power solution.

The RCB600 power supply consists of an input module that provides four isolated slots where can be plugged in up to five output modules of any type in any combination. Output modules are available in four single nominal output voltages: 5, 12, 24 and 48 V and one double nominal 12V outputs, each of them offering an extremely wide voltage adjustability range.

A built in fan and its speed control circuit assure proper forced air cooling minimizing operation noise and enhancing the power supply service life time.



The RCB series are certified to IEC/EN/UL/CSA 60950-1 2nd Edition for IT and Industrial equipment. The series meets the EN55022 EMC limits of Class B for conducted and radiated emissions as well as the EN 61000-3 and EN 61000-4 EMC standards.

KEY FEATURES

- Universal input voltage (active PFC)
- High power density (23 W/in³)
- 600 W output in a 5"x3"x1U form factor
- Fan speed control function / quiet operation
- Modular, configurable power supply
- Output modules parallel / series operation(*)
- Accurate wired current share
- Remote voltage/current programming /control
- Output current monitoring signal
- +5 V, 200 mA bias supply
- IEC/EN/UL/CSA 60950-1, 2nd Edition
- RoHS directive 2011/65/UE compliant

(*) Reference the User Manual or contact the factory for parallel operation across multiple chassis.

MARKET SEGMENTS AND APPLICATIONS

- Information Technology Equipment
- Test and Measurement Equipment
- Automation and Drives
- Broadcast and Entertainment
- Printing devices
- Industrial and Process Control

MODELS AND ORDERING INFORMATION

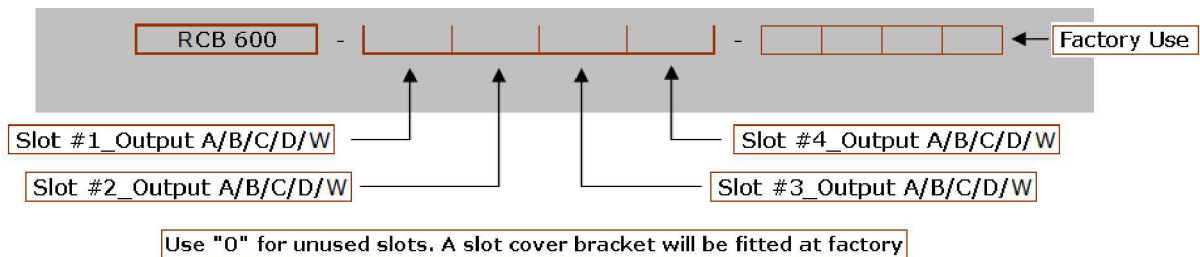

The factory might issue a 4 digit code for a specific configuration which can be used for next and future orders of the same configuration
When ordering an input unit with no output inserted, simply order "MCB600"

Output Module	Nominal Voltage	Voltage Adjustment	Output Rated Power	Rated Current	Max Current at Nom Voltage	Load Regulation	Over Voltage trip level	
A	5 V	1.5 to 7.5 V	125 W	25.0 A	25 A	±50 mV	9.5 V	
B	12 V	4.5 to 15 V	150 W	15.0 A	12.5 A	±100 mV	18 V	
C	24 V	9 to 30 V	150 W	7.5 A	6.25 A	±150 mV	36 V	
D	48 V	18 to 58 V	150 W	3.75 A	3.13 A	±300 mV	66 V	
W	2x12 V	3.3 to 15 V	2X 75 W	5.0 A	5.0 A	±50 mV	20 V	
0 (zero)			Metal blanking plate for unused slots.					

INPUT SPECIFICATIONS

Parameter	Details	Min	Typ	Max	Units
AC input voltage	Nominal range is 100 to 240 V _{RMS}	85		264	V _{RMS}
AC input frequency		47	50/60	63	Hz
DC input voltage		120		300	V _{DC}
Power rating	Derate by 0.83%/V _{RMS} below 120 V _{RMS} (600 W at 120 V _{RMS} , 450 W at 90 V _{RMS})			600	W
Input current	At 600 W output and 120 V _{RMS} input			6	A
Inrush current	265 V _{RMS} , cold start			20	A
Fusing	5x20 fast acting fuse			8	A
Input current limit	Maintains power factor		8		A
Efficiency	Configuration dependent		86	89	%
Idle power	All outputs fitted and enabled All outputs fitted and disabled		28 21		W
Power factor	Typical value at 300 W output at 240 V _{RMS}		0.96	0.99	
Hold up	600 W output at 120 V _{RMS} input	17	20	21	ms
UVLO	Turn on only	78		84	V _{RMS}
Over temperature	Internally monitored. Latching	115		125	°C
Reliability	At 40 °C, 80% load			2	FPMH

SIGNALS

Parameter	Details	Min	Typ	Max	Units
Bias voltage		4.8	5	5.2	V
Bias current		0		200	mA
Power Good Voltage	PNP open collector with internal 10 kΩ pull down resistor	8	10	15	V
Power Good Current		0		20	mA
Individual inhibit voltage	Apply ≥ 5 V when used as Global Inhibit.	2		15	V
Inhibit current	10 kΩ input impedance	0.2		1.5	mA
Global inhibit voltage		3		15	V
Global inhibit current	5 kΩ input impedance	0.6		3	mA
AC_OK voltage		1		4	V
AC_OK current		-10		20	mA
AC_OK warning	See user manual for exceptions	5			ms

ENVIRONMENTAL, INSTALLATION AND RELIABILITY

Parameter	Details	Min	Max	Units
Storage				
Temperature		-40	+85	°C
Humidity	Relative, non-condensing	5	95	%
Altitude		-200	5000	m
Air Pressure		54	106	kPa
Operating				
Temperature	Full power De-rating input and output at 2.5% / °C	-20	50	°C
Humidity	Relative, non-condensing	5	95	%
Altitude		-200	4600	m
Air Pressure		69	106	kPa
Acoustic Noise	Variable to input voltage, ambient temperature, load Measured at 1 m from fan intake	35	60	dB(A)
Shock	3000 bumps at 10 g (16 ms) half sine wave			
Vibration	1.5 g, 10 to 200 Hz sine wave, 20 g for 15 min in three axes random vibration			
Installation				
Equipment Class	I			
Installation Category	Category II			
Pollution Degree	2			
Material Group	IIIb (indoor use only)			
Flammability Rating	94V-2			
IP Rating	IP10			
RoHS Compliance	Directive 2011/65/UE			
Reliability				
Fan	Mag Lev Std		2.7	FPMH
Power unit	Input + Transformer modules excluding fan		2	FPMH
Output Modules	See individual output data-sheets		1	FPMH
Warranty			2	Years



ELECTROMAGNETIC COMPATIBILITY (EMC)

Parameter	Standard	Level
Emissions		
Radiated electric field	EN55011, EN55022, FCC	B
Conducted emissions	EN55011, EN55022, FCC	B
Harmonic distortion	EN61000-3-2	Compliant
Flicker and fluctuation	EN61000-3-3	Compliant
Immunity		
Electrostatic discharge	EN61000-4-2 (15 kV air, 8 kV contact)	4
Radiated RFI	EN61000-4-3 (10 V/m)	3
Fast transient, burst	EN61000-4-4 (4 kV)	4
Input line surges	EN61000-4-5 (1 kV L-N, 2 kV L-E)	3
Conducted RFI	EN61000-4-6 (10 V)	4
Power freq. Magnetic field	EN61000-4-8 (10 A/m)	3
Voltage dips	EN61000-4-11 (EN55024)	Compliant

SAFETY PARAMETERS AND AGENCY APPROVALS

Parameter	Details	Min	Max	Units
Isolation Voltage	Primary to Secondary	4000		V _{RMS}
	Primary to Protection Earth (chassis)	1500		V _{RMS}
Isolation Clearance	Primary to Secondary	7		mm
	Primary to Chassis	2.5		mm
Isolation Creepage	Primary to Secondary	12		mm
	Primary to Chassis	4		mm
Earth Leakage Current	265 V _{AC} , 63 Hz, 25 °C ambient		300	µA
Safety Standards	IEC / EN 60950-1; UL 60950-1; CAN/CSA-C22.2 No. 950.1, 2 nd Ed. CE: Directive 2006/95/EC (low voltage requirement); Directive 2004/108/EC (EMC); Directive 2011/65/EU (RoHS)			
Agency Approvals and File Numbers	Designed to meet IEC/EN/UL/CSA 61010-1 2 nd edition UL: E134098-A35-UL CB Certificate: DK-21001 Demko Certificate: 152969-02			

TYPICAL CONDUCTED EMISSION

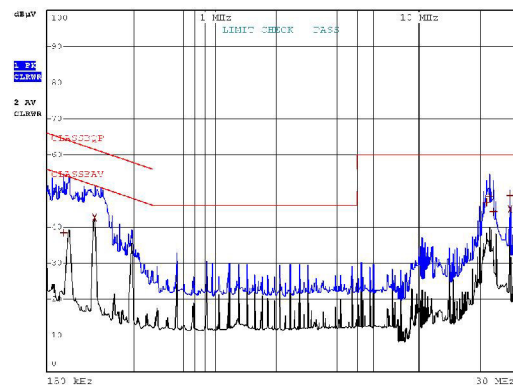
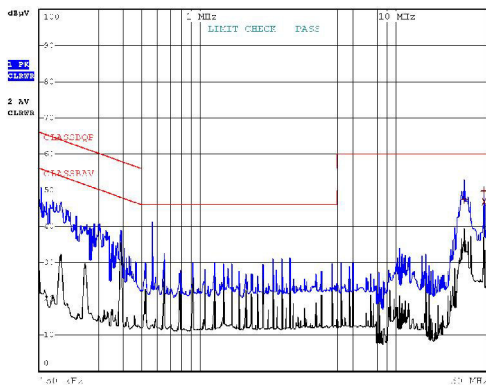

TEMPERATURE AND INPUT VOLTAGE DE-RATINGS

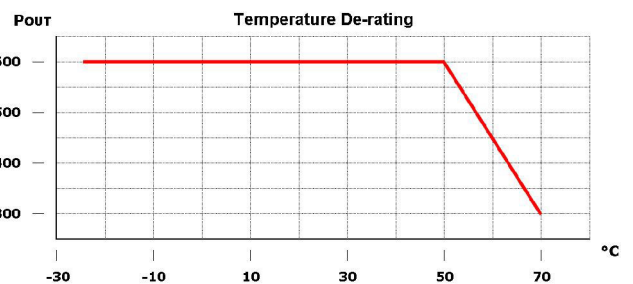
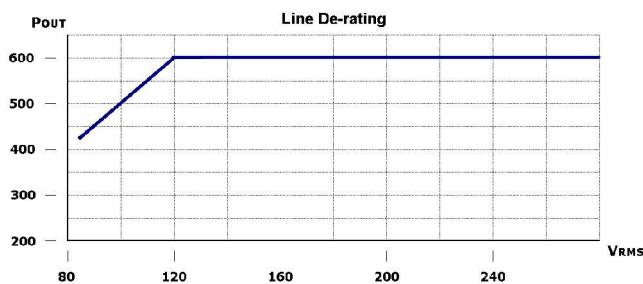

MECHANICAL SPECIFICATIONS – OUTLINE DRAWING AND DIMENSIONS

Specification	Details	Nominal	Units
Dimensions	Height is 1U	77.7 x 136.25 x 41.0	mm
		3.06 x 5.36 x 1.61	in
Weight	Chassis + input	360	g
	Output modules	60	g
	Chassis + input	0.794	lb
	Output modules	0.132	lb
Mounting	Bottom or side mounting through M4 screws	M4	

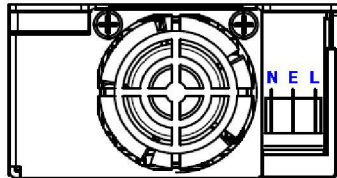

N - Neutral
E - Earth
L - Live

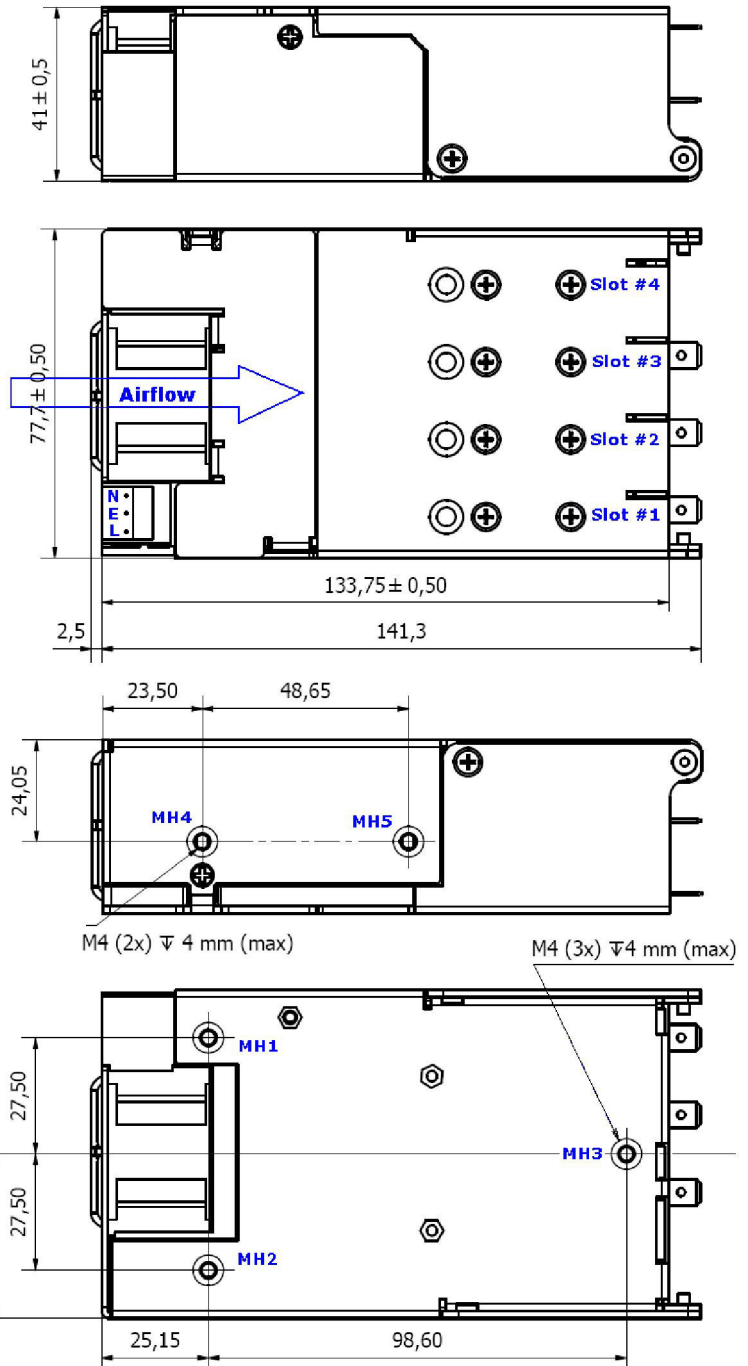

SCREWS

MH1, MH2, MH3, MH4, MH5

Screw type	M4
Tightening torque	Tighten to 1.5 Nm
Penetration depth	4.00 mm max, including chassis

OUTPUT MODULES X 8

Screw type	M3X5, C/Sink, Posi, Stainless steel
Tightening torque	Tighten to 0.75 Nm
Penetration depth	Defined by screw

CHASSIS X 2

Screw type	M3X5, C/Sink, Posi, Stainless steel
Tightening torque	Tighten to 0.75 Nm
Penetration depth	Defined by screw

CHASSIS X 2

Screw type	M2.5X4, C/Sink, Posi, Stainless steel
Tightening torque	Tighten to 0.45 Nm
Penetration depth	Defined by screw

FAN X 2

Screw type	M3X30, C/Sink, Posi, Stainless steel
Tightening torque	Tighten to 0.70 Nm
Penetration depth	Defined by screw

MECHANICAL SPECIFICATIONS – CONNECTORS AND PIN ASSIGNMENT

PIN ASSIGNMENT	
Circuit	Details
J1	
1	Neutral
2	Earth
3	Live
J2	
1	Power Good Slot #1
2	Inhibit Slot #1
3	Power Good Slot #2
4	Inhibit Slot #2
5	Power Good Slot #3
6	Inhibit Slot #3
7	Power Good Slot #4
8	Inhibit Slot #4
9	Global Inhibit
10	AC OK
11	+5V 200mA, Bias Supply
12	COM
J5	
1	-Sense
2	+Sense
3	Voltage Control
4	Current Control
5	Current Sharing
6	Current Monitor
7	COM
8	+5V 10mA, Bias Supply
J3	
Positive Output	
J4	
Negative Output	

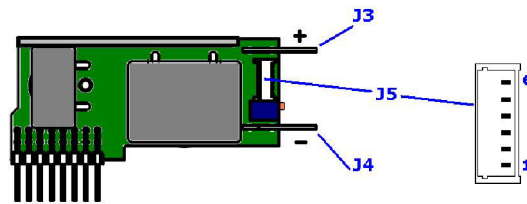
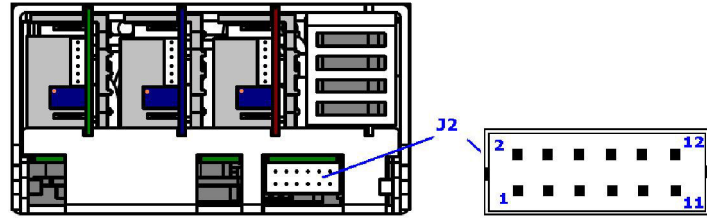
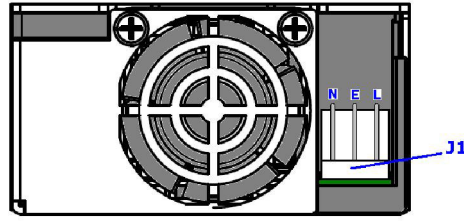

COUNTERPART CONNECTORS

Reference	Details	Manufacturer	Housing PN	Terminal PN
AC Mains Input J1	<ul style="list-style-type: none"> 5.08 mm (0.200 in), 3 circuits housing, with friction lock, or any direct equivalent. Crimp terminal, 18-24 AWG, tin finish, or, any direct equivalent. 	Molex	0010013036	0008701031
Power Unit Signal J2	<ul style="list-style-type: none"> 2.00 mm (0.079 in) 12 circuits housing with locking ramp, or, any direct equivalent. Crimp terminal 24-30 AWG, gold finish, or, any direct equivalent. 	Molex	0511101260	0503948051
Output Power J3/J4	<ul style="list-style-type: none"> Quick Disconnect Receptacle compatible with PCB mounting TAB, size 0.80X6.35 mm. Tin finish. 	Vogt AG Tyco Electronics	NA	3967 640907-1
Output Signal J5	<ul style="list-style-type: none"> 1.25 mm (0.049 in), 6 circuits housing, Crimp terminal 28-32 AWG, tin finish, or, any direct equivalent 	Molex	0510210600	0500588000

Notes:

- Output power terminal and wire current rating must exceed maximum short circuit output current (OP-A: 25*1.25 = 31.25 A)
- Direct equivalents may be used for any connectors parts
- All cables must be rated 105°C min, equivalent to UL1015.

Dual Output Module – OPW – Pin Assignment and Outline drawing

Circuit	Description
V1 and V2 Output Voltages	
MOLEX 0430450400	
1	-V1
2	-V2
3	+V1
4	+V2
Signals	
MOLEX 0530480510	
1	S ⁻ (V2)
2	S ⁺ (V2)
3	Not connected
4	S ⁻ (V1)
5	S ⁺ (V1)

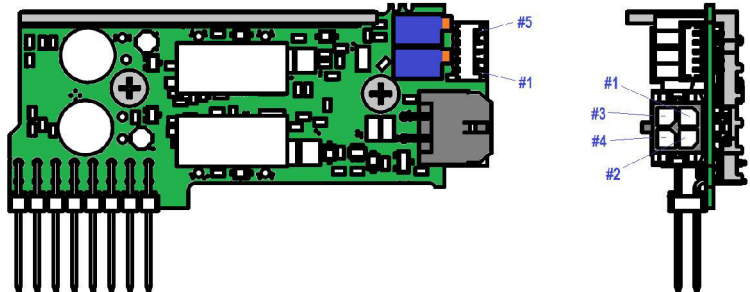

OP-W Counterpart Connectors

Reference	Details	Manufacturer	Housing PN	Crimp Terminal PN
V1 /V2 Outputs	<ul style="list-style-type: none"> Micro-Fit 3.0™ Receptacle Housing, Dual Row, 4 Circuits, Halogen Free. Micro-Fit 3.0™ Crimp Terminal, Female, with Tin (Sn) Plated Phosphor Bronze Contact, 20-24 AWG 	Molex	0430250400	43030-0001
Signals	<ul style="list-style-type: none"> 1.25mm Pitch PicoBlade™ Wire-to-Wire and Wire-to-Board Housing, Female, 5 Circuits. 1.25mm Pitch PicoBlade™ Crimp Terminal, Female, 28-32 AWG. 	Molex	51021-0500	50058-8000

OUTPUT SPECIFICATIONS – MODULE A (OP-A)

Parameter	Test conditions / Notes	Min	Nominal	Max	Units
Output voltage range		1.5	5	7.5	V
Rated current				25	A
Average output power				125	W
Peak output power	<5 s, 50% duty cycle			187.5	W
Initial voltage accuracy	Factory set units, Measured at sense terminals	-0.5		0.5	% V _{SET}
Output voltage adjustment	Manual: 11-turns potentiometer		0.545		V/turn
Load regulation	Measured at sense terminals	-50		50	mV
Line regulation	Measured at sense terminals	-0.1		0.1	%V _{NOM}
Cross regulation	Measured at sense terminals	-0.2		0.2	%V _{NOM}
Minimum load			0		A
Output temperature drift		-0.02		0.02	%/°C
Ripple and Noise	20 MHz bandwidth, peak-peak			1	%V _{NOM}
Transient response	25% to 75% load transient, at 1A/μs, recovery to within 10% of V _{SET}			100	μs
Turn on rise time	Monotonic, 10% to 90%	1.5		3.5	ms
Turn on overshoot				0.1	%V _{SET}
Turn on delay	From AC on to Power Good From Enable to Power Good		600 15	750 20	ms ms
Current sharing accuracy				5	%I _{MAX}
Open sense offset	Open sense, voltage offset due to bias currents			2	%V _{NOM}
Hold-up voltage				6	V
Isolation to ground	Each terminal			250	V
Over current protection	% of rated current	105		125	%I _{RATED}
Reverse current protection	% of rated current	-6		0	%I _{RATED}
Short circuit protection (Hiccup mode)	Period Duty cycle Voltage threshold (at sense)		125 3 1		ms % V
Over voltage protection	Latching		9.5		V
Over temperature protection	Internally monitored, latching	115		125	°C
Sense cable protection	On positive terminal On negative terminal	-1 none		2 1	V
Power good threshold	Low threshold only		90		%V _{SET}
Output current signal	$I_{SGN} = 0.6 + I_{OUT}/(I_{RTD} * 1.25)$	0		110	%I _{RATED}
Current limit control	$I_{LMT} = (V_{CTRL} - 0.6) * I_{RTD} * 1.25$	0		110	%I _{RATED}
Remote voltage control	$V_{OUT} = V_{SET} ((1.8 - V_{CTRL}) / 0.6)$	0		300	%V _{SET}
Bias supply	10 mA max	4.5	5	5.2	V
Reliability	At 40 °C, 80% load			1	FPMH
Warranty				2	Years
Wire size	Power cables	12	10		AWG
Weight				60	g
Size	60 mm x 35 mm x 17 mm, or, 2.36 in x 1.38 in x 0.67 in				

OUTPUT SPECIFICATIONS – MODULE B (OP-B)

Parameter	Test conditions / Notes	Min	Nominal	Max	Units
Output voltage range		4.5	12	15	V
Rated current				15	A
Average output power				150	W
Peak output power	<5 s, 50% duty cycle			225	W
Initial voltage accuracy	Factory set units, Measured at sense terminals	-0.5		0.5	% V _{SET}
Output voltage adjustment	Manual: 11-turns potentiometer		0.954		V/turn
Load regulation	Measured at sense terminals	-100		100	mV
Line regulation	Measured at sense terminals	-0.1		0.1	%V _{NOM}
Cross regulation	Measured at sense terminals	-0.2		0.2	%V _{NOM}
Minimum load			0		A
Output temperature drift		-0.02		0.02	%/°C
Ripple and Noise	20 MHz bandwidth, peak-peak			1	%V _{NOM}
Transient response	25% to 75% load transient, at 0.5A/μs; recovery to within 10% of V _{SET}			1.5	V
Turn on rise time	Monotonic, 10% to 90%	1.5		3.5	ms
Turn on overshoot				0.1	%V _{SET}
Turn on delay	From AC on to Power Good		600	750	ms
	From Enable to Power Good		15	20	ms
Current sharing accuracy				5	%I _{MAX}
Open sense offset	Open sense, voltage offset due to bias currents			2	%V _{NOM}
Hold-up voltage				12.5	V
Isolation to ground	Each terminal			250	V
Over current protection	% of rated current	105		125	%I _{RATED}
Reverse current protection	% of rated current	-6		0	%I _{RATED}
Short circuit protection (Hiccup mode)	Period		125		ms
	Duty cycle		3		%
	Voltage threshold (at sense)		2		V
Over voltage protection	Latching		18		V
Over temperature protection	Internally monitored, latching	115		125	°C
Sense cable protection	On positive terminal	-1		2	V
	On negative terminal	none		1	V
Power good threshold	Low threshold only		90		%V _{NOM}
Output current signal	$I_{SGN} = 0.6 + I_{OUT}/(I_{RTD} * 1.25)$	0		110	%I _{RATED}
Current limit control	$I_{LMT} = (V_{CTRL} - 0.6) * I_{RTD} * 1.25$	0		110	%I _{RATED}
Remote voltage control	$V_{OUT} = V_{SET} ((1.8 - V_{CTRL}) / 0.6)$	0		300	%V _{SET}
Bias supply	10 mA maximum	4.5	5	5.2	V
Reliability	At 40 °C, 80% load			1	FPMH
Warranty				2	Years
Wire size	Power cables	16	14	10	AWG
Weight				60	g
Size	60 mm x 35 mm x 17 mm, or, 2.36 in x 1.38 in x 0.67 in				

OUTPUT SPECIFICATIONS – MODULE C (OP-C)

Parameter	Test conditions / Notes	Min	Nominal	Max	Units
Output voltage range		9	24	30	V
Rated current				7.5	A
Average output power				150	W
Peak output power	<5 s, 50% duty cycle			225	W
Initial voltage accuracy	Factory set units, Measured at sense terminals	-0.5		0.5	% V _{SET}
Output voltage adjustment	Manual: 11-turns potentiometer		1.9		V/turn
Load regulation	Measured at sense terminals	-150		150	mV
Line regulation	Measured at sense terminals	-0.1		0.1	%V _{NOM}
Cross regulation	Measured at sense terminals	-0.2		0.2	%V _{NOM}
Minimum load			0		A
Output temperature drift		-0.02		0.02	%/°C
Ripple and Noise	20 MHz bandwidth, peak-peak			1	%V _{NOM}
Transient response	25% to 75% load transient, at 0.25A/μs; recovery to within 10% of V _{SET}			3	V
Turn on rise time	Monotonic, 10% to 90%	1.5		3.5	ms
Turn on overshoot				0.1	%V _{SET}
Turn on delay	From AC on to Power Good		600	750	ms
	From Enable to Power Good		15	20	ms
Current sharing accuracy				5	%I _{MAX}
Open sense offset	Open sense, voltage offset due to bias currents			2	%V _{NOM}
Hold-up voltage				25	V
Isolation to ground	Each terminal			250	V
Over current protection	% of rated current	105		125	%I _{RATED}
Reverse current protection	% of rated current	-6		0	%I _{RATED}
Short circuit protection (Hiccup mode)	Period		125		ms
	Duty cycle		3		%
	Voltage threshold (at sense)		3.5		V
Over voltage protection	Latching		36		V
Over temperature protection	Internally monitored, latching	115		125	°C
Sense cable protection	On positive terminal	-1		2	V
	On negative terminal	none		1	V
Power good threshold	Low threshold only		90		%V _{SET}
Output current signal	$I_{SGN} = 0.6 + I_{OUT}/(I_{RTD} * 1.25)$	0		110	%I _{RATED}
Current limit control	$I_{LMT} = (V_{CTRL} - 0.6) * I_{RTD} * 1.25$	0		110	%I _{RATED}
Remote voltage control	$V_{OUT} = V_{SET} ((1.8 - V_{CTRL}) / 0.6)$	0		300	%V _{SET}
Bias supply	10 mA max	4.5	5	5.2	V
Reliability	At 40 °C, 80% load			1	FPMH
Warranty				2	Years
Wire size	Power cables	20	18	10	AWG
Weight				60	g
Size	60 mm x 35 mm x 17 mm, or, 2.36 in x 1.38 in x 0.67 in				

OUTPUT SPECIFICATIONS – MODULE D (OP-D)

Parameter	Test conditions / Notes	Min	Nominal	Max	Units
Output voltage range		18	48	58	
Rated current				3.75	A
Average output power				150	W
Peak output power	Less than 5 s, 50% duty cycle			225	W
Initial voltage accuracy	Factory set units, Measured at sense terminals	-0.5		0.5	% V _{SET}
Output voltage adjustment	Manual: 11-turns potentiometer		3.6		V/turn
Load regulation	Measured at sense terminals	-300		300	mV
Line regulation	Measured at sense terminals	-0.1		0.1	%V _{NOM}
Cross regulation	Measured at sense terminals	-0.2		0.2	%V _{NOM}
Minimum load			0		A
Output temperature drift		-0.02		0.02	%/°C
Ripple and Noise	20 MHz bandwidth, peak-peak			1	%V _{NOM}
	25% to 75% load transient, at 0.25A/μs; recovery to within 10% of V _{SET}			3	V
Transient response				100	μs
Turn on rise time	Monotonic, 10% to 90%	1.5		3.5	ms
Turn on overshoot				0.1	%V _{SET}
Turn on delay	From AC on to Power Good		600	750	ms
	From Enable to Power Good		15	20	ms
Current sharing accuracy				5	%I _{MAX}
Open sense offset	Open sense, voltage offset due to bias currents			2	%V _{NOM}
Hold-up voltage				50	V
Isolation to ground	Each terminal			250	V
Over current protection	% of rated current	105		125	%I _{RATED}
Reverse current protection	% of rated current	-6		0	%I _{RATED}
Short circuit protection (Hiccup mode)	Period		125		ms
	Duty cycle		3		%
	Voltage threshold (at sense)		3.5		V
Over voltage protection	Latching		66		V
Over temperature protection	Internally monitored, latching	115		125	°C
Sense cable protection	On positive terminal	-3		3	V
	On negative terminal	none		2	V
Power good threshold	Low threshold only		90		%V _{SET}
Output current signal	$I_{SGN} = 0.6 + I_{OUT}/(I_{RTD} * 1.25)$	0		110	%I _{RATED}
Current limit control	$I_{LMT} = (V_{CTRL} - 0.6) * I_{RTD} * 1.25$	0		110	%I _{RATED}
Remote voltage control	$V_{OUT} = V_{SET} ((1.8 - V_{CTRL}) / 0.6)$	0		300	%V _{SET}
Bias supply	10 mA max	4.5	5	5.2	V
Reliability	At 40 °C, 80% load			1	FPMH
Warranty				2	Years
Wire size	Power cables	20	18	10	AWG
Weight				60	g
Size	60 mm x 35 mm x 17 mm, or, 2.36 in x 1.38 in x 0.67 in				

OUTPUT SPECIFICATIONS – MODULE W (OP-W)

Parameter	Test conditions / Notes	Min	Nominal	Max	Units
Voltage range	Each channel	3.3	12	15	V
Rated current	Each channel			5.0	A
Rated power	Each channel			75	W
Initial voltage accuracy	Factory set units	-1		1	% V _{SET}
Voltage adjustment	Manual: 11-turns potentiometer		1.1		V/turn
Load regulation	Measured at sense terminals	-50		50	mV
Line regulation	Measured at sense terminals	-0.1		0.1	%V _{NOM}
Cross regulation	Measured at sense terminals	-0.2		0.2	%V _{NOM}
Minimum load			0		A
Temperature drift		-0.02		0.02	%/°C
Ripple and Noise	20 MHz bandwidth, peak-to-peak V _{SET} : 12 V			2	%V _{NOM}
Transient response	25% to 75% load transient, at 1A/μs, recovery to within 10% of V _{SET}			1 200	V μs
Turn on rise time	Monotonic, 10 to 90 %	4.5	5.5	6.5	ms
Turn on overshoot				0.1	%V _{SET}
Turn on delay	From AC on (120 V _{AC}) to Power Good From Enable to Power Good	250 15	- -	350 25	ms
Hold-up voltage				12	V
V1/V2 Isolation to ground	Each terminal			250	V
Isolation V1 to V2	Each terminal			250	V
Over current protection	Hiccup mode	105		125	%I _{RATED}
Reverse current protection	None				%I _{RATED}
Short circuit protection	Hiccup period Hiccup duty cycle		50 25		ms %
Over voltage protection	Latching	19	20	21	V
Over temperature protection	Internally monitored, latching	115		125	°C
Power good threshold	High threshold Low threshold only	90 88	94 92	98 95	%V _{SET}
Reliability	At 40 °C, 80% duty cycle, 100% load Telcordia SR-332 Issue 2			1	FPMH
Warranty				2	Years
Wire size	Power cables	20	18	10	AWG
Size and weight	(27.5 x 65.9 x 15.7) mm; (1.08 x 2.59 x 0.62) in; 60 g 2.1 oz				

Roal Electronics, S.p.A. may change product specifications and accordingly the information presented in this document. Customers are responsible for their products and applications using Roal Electronics, S.p.A. products. Roal Electronics, S.p.A. assumes no liability from the use of its products outside of specifications. No license is granted to any intellectual property rights by this document. ROAL ELECTRONICS, S.P.A. DISCLAIMS ALL REPRESENTATIONS AND WARRANTIES OF ANY KIND, EXPRESS OR IMPLIED, INCLUDING, BUT NOT LIMITED TO, IMPLIED WARRANTIES OF NONINFRINGEMENT, MERCHANTABILITY AND FITNESS FOR A PARTICULAR PURPOSE.

Europe, Middle East and Africa

ROAL Electronics S.p.A
Via Jesina 56/A
60022 - Castelfidardo (AN) - Italy
Tel: +39 071 721461
Fax: +39 071 72146 480

www.roallivingenergy.com

North America

ROAL Electronics USA, Inc.
701, Main St. Suite 405
Stroudsburg, PA18360
Phone: + 1 570 421 5750
Fax: +1 570 421 5687

DS_RCB600_Rev06 – October 12, 2015

FORTEC

ELEKTRONIK AG

Our company network supports you worldwide with offices in Germany, Austria, Switzerland, Great Britain and the USA. For more information please contact:

FORTEC Elektronik AG

Hauptniederlassung
Lechwiesenstr. 9
86899 Landsberg am Lech

Telefon: +49 (0) 8191 91172-0
Telefax: +49 (0) 8191 21770
E-Mail: sales@fortecag.de
Internet: www.fortecag.de

FORTEC Elektronik AG

Büro Nord
Am Hasenkamp 36
22457 Hamburg

Telefon: +49 (0) 40 54 80 56 11
Telefax: +49 (0) 40 54 80 56 13
E-Mail: nord@fortecag.de
Internet: www.fortecag.de

FORTEC Elektronik AG

Büro West
Hohenstaufenring 55
50674 Köln

Telefon: +49 (0) 221 272 273-0
Telefax: +49 (0) 221 272 273-10
E-Mail: west@fortecag.de
Internet: www.fortecag.de

FORTEC Elektronik AG

Büro Wien
Nuschinggasse 12
A-1230 Wien

Telefon: +43 1 8673492-0
Telefax: +43 1 8673492-26
E-Mail: office@fortec.at
Internet: www.fortec.at

ALTRAC AG

(Tochter der Fortec AG):
Bahnhofstraße 3
CH-5436 Würenlos

Telefon: +41 (0) 44 7446111
Telefax: +41 (0) 44 7446161
E-Mail: info@altrac.ch
Internet: www.altrac.ch

Members of the FORTEC Group:

